

## Side Emit SMD LED 1.1mm Height

### Description

The constructive of this series of LED are different from the PCB type SMD LED. The lead-frame is of material, reflector is made of thermoplastic and construct into this unique type of SMD LED. The wavelengths and luminous Intensities of this series are grouped under 20mA for uniformity.

### VR 32G8



### Applications

- Dashboards and switch
- Backlight keypads
- Industrial control systems signal indicator
- Automotive features
- Telephone and fax backlighting or indicator



### Electronic Optical Characteristics (at 20mA):

Part Number	Emitted Color	$\lambda d$ (nm)		Lens Color	Iv(mcd)		View Angle	VF(V)	
		Min.	Max.		Min.	Typ.		Typ.	Max.
VR 32G8	Blue 	451	463	Clear	180	270	120	3.25	3.75

### Absolute Maximum Ratings (at Ta=25°C)

P <sub>D</sub> (mW)	I <sub>F</sub> (mA)	I <sub>FM</sub> (mA)	T <sub>sol</sub> (°C)	T <sub>J</sub> (°C)	T <sub>opr</sub> (°C)	T <sub>stg</sub> (°C)
112	30	300	260 for 30 sec.	125	-40~+110	-40~+110

Note: Please take note the Absolute Maximum Rating values. Any operation beyond the specified ratings in this table will result degradation of LED life-span and may cause LED to fail.

\* I<sub>FM</sub>: Surge Current (t<=10μs, D=0.005, T<sub>S</sub>=25°C)

**Package Dimension:**

unit:mm

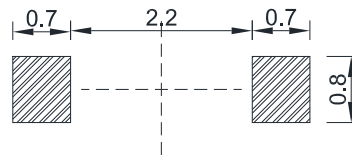
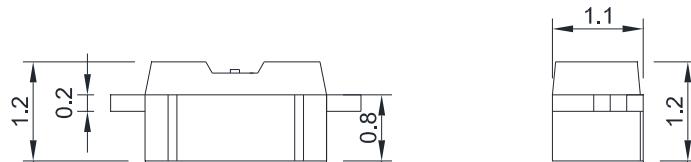
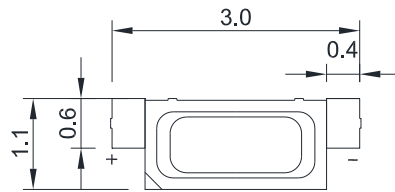

Recommended Soldering Pad

**Notes:**

1. All dimensions are millimeters.
2. Tolerance is  $\pm 0.2\text{mm}$  unless otherwise specified.
3. Specifications are subject to change without notice.

### Reel Dimension:

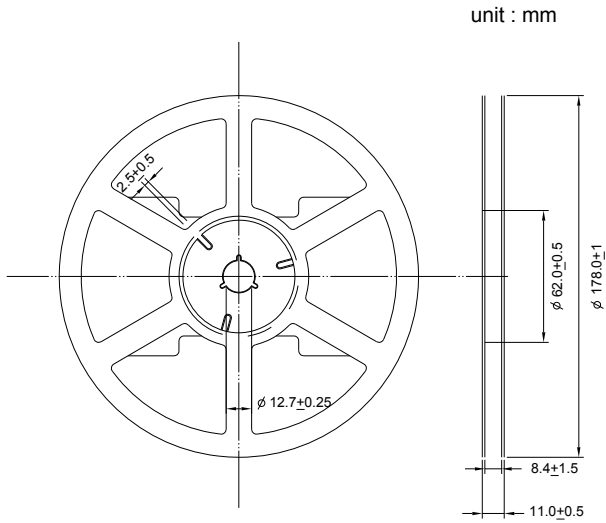

Note:

Available in 8mm carrier tape on 178mm diameter reels. (2,000 pieces)

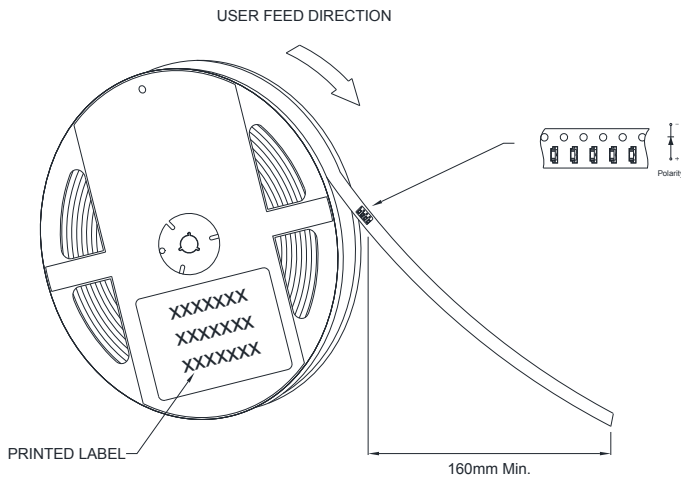

Note:

A spacing of approximately 160mm between the front edge of tape

### Tape Dimension:

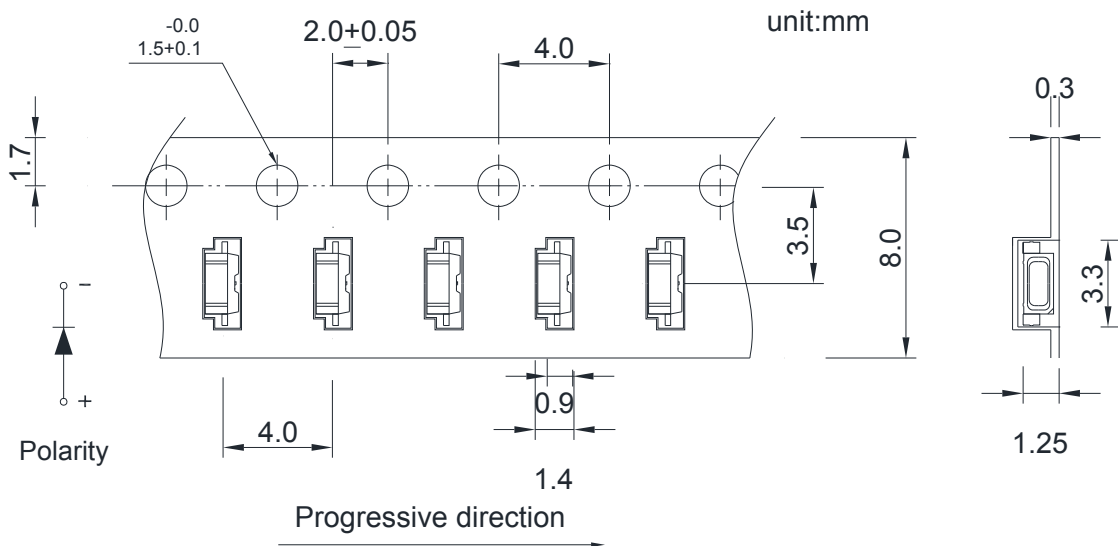

## Optical Characteristics Curves

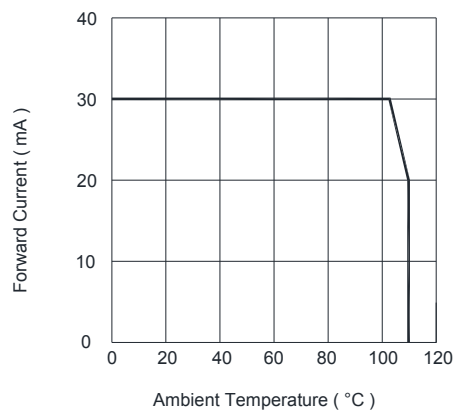
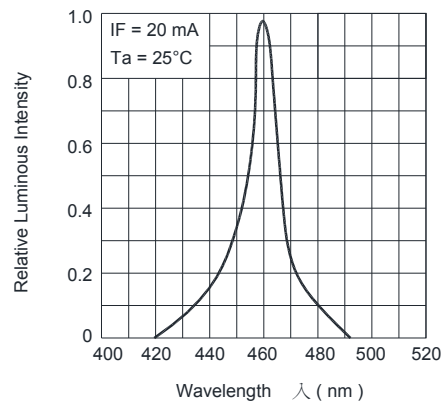
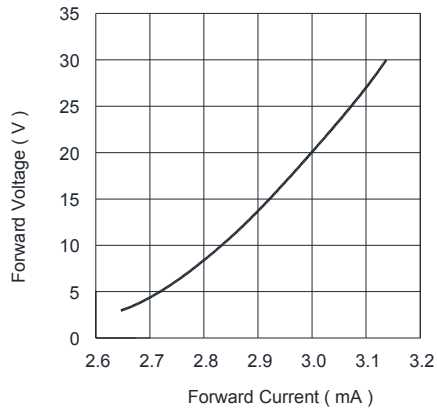
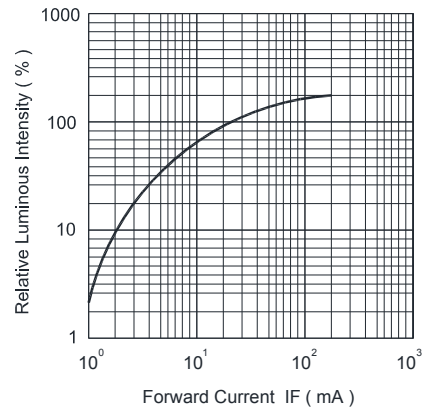
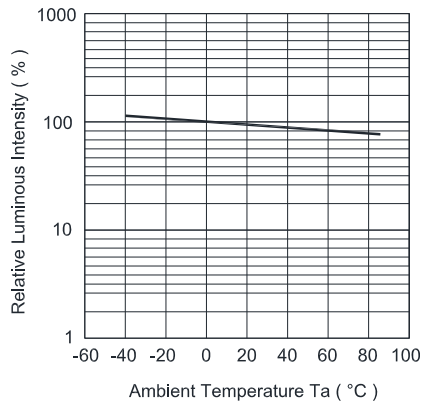

**Recommended Pb-free re-flow soldering profile:**

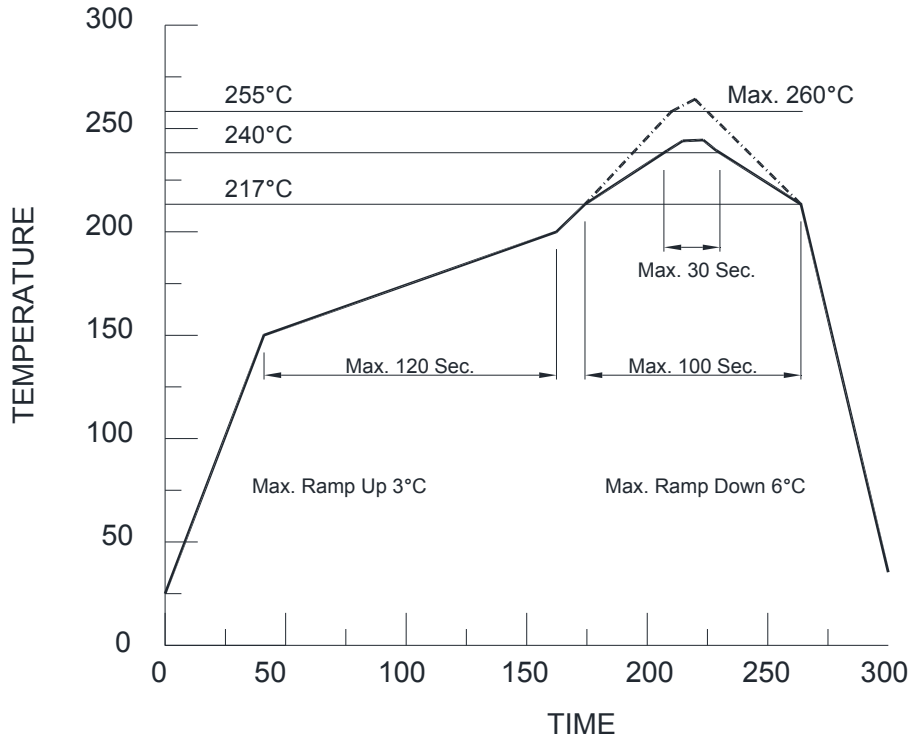

**Note:**

All the specifications listed in this data sheet are suitable for general electronic equipment, office equipment and communication devices. Kindly consult Sales Representatives for specific reliabilities request, Forward Voltage, Luminous Intensity, Wavelength, Radiant Power or Viewing Angle.