

1.2” Single Digit Display C.C.

VP U51CG

Main Features:

- Low Power Consumption
- High Efficiency Chips Material
- Excellent Character Appearance
- Long Life Solid State Reliability
- Common Cathode configuration
- Gray color surface reflector with white diffuse segments

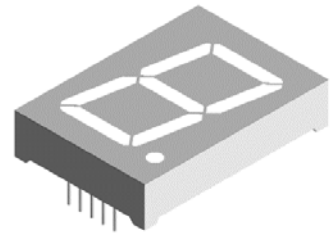

Applications

- Industry equipment
- Instruments panels
- Counter equipment

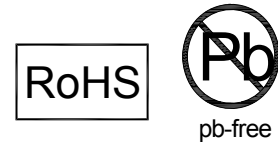

Electronic Optical Characteristics (@ 10mA):

Part Number	Emitted Color	λ (nm)		Surface Color	mcd (Per segment)		VF	
		λd	λp		Min.	Typ.	Typ.	Max.
VP U51CG	Green 	573	575	Gray	5.6	18.0	2.0	2.4

Absolute Maximum Ratings (@ Ta=25°C)

Emitted Color	P _D (mW)	ESD(V)	I _F (mA)	T _{sol} (°C)	I _R (μ A)@V _R =5V	T _{opr} (°C)	T _{stg} (°C)
Green	60	2000	25	260 \pm 5	10	-40~+85	-40~+100

Note: Please take note the Absolute Maximum Rating values. Any operation beyond the specified ratings in this table will result degradation of LED life-span and may cause LED to fail.

Package Dimension:

unit: mm

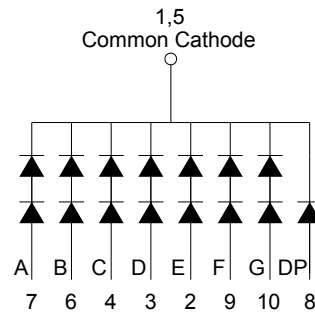
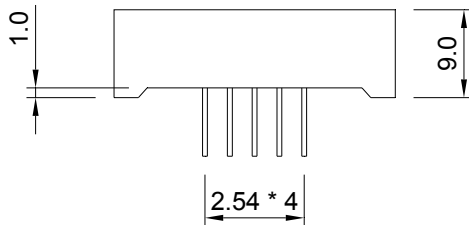
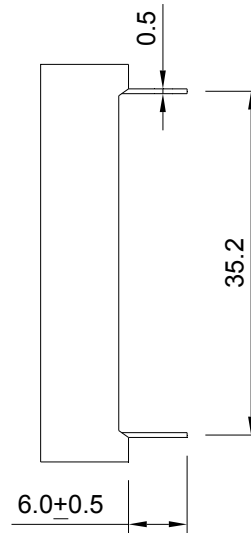
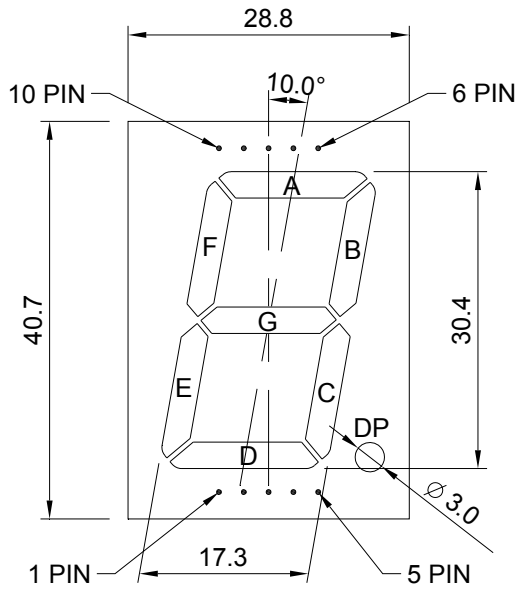

Notes:

1. All dimensions are millimeters.
2. Dimensional tolerance is ± 0.2 mm unless otherwise specified.
3. Specifications are subject to change without notice.

Optical Characteristics Curves

