

Planar Package SMD Silicon Photodiode

OD LD47

Features

- High radiant sensitive
- Low junction capacitance
- Wide radiant sensitive area
- Fast respond speed.
- Daylight filter
- Lens in black color

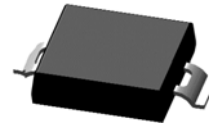

Applications

- Industrial electronics
- Measurement
- Control Circuit
- Interrupter



Absolute Maximum Rating $T_a = 25^\circ\text{C}$, unless otherwise specified

Parameter	Symbol	Value	Unit
Reverse Voltage	V_R	32	V
Power Dissipation	P_C	150	mW
Operating Temperature Range	T_{amb}	-30 to + 85	$^\circ\text{C}$
Storage Temperature	T_{stg}	-40 to + 85	$^\circ\text{C}$
Soldering Temperature	T_{sd}	260	$^\circ\text{C}$

Note: Please take note the Absolute Maximum Rating values. Any operation beyond the specified ratings in this table will result degradation of LED life- span and may cause LED to fail.

Package Dimension:

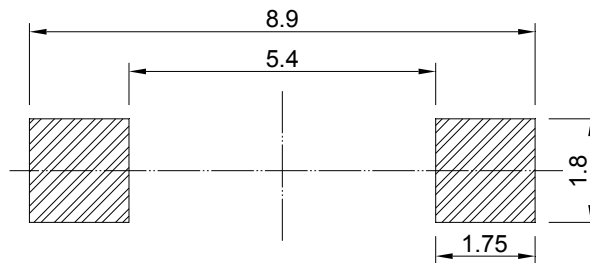
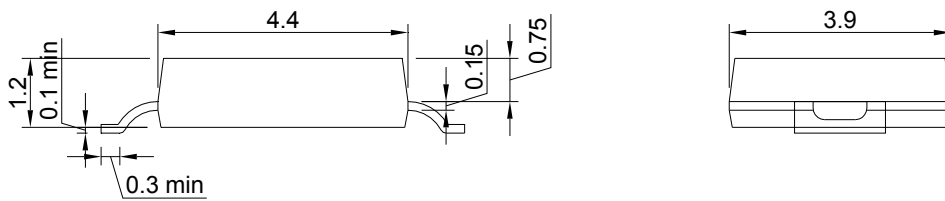
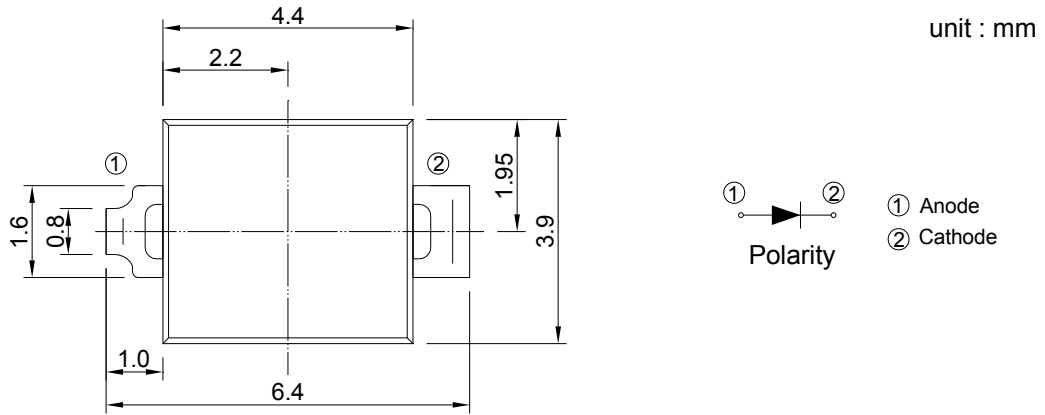

Recommended Soldering Pad

Notes:

1. All dimensions are millimeters.
2. Tolerance is $\pm 0.2\text{mm}$ unless otherwise specified.
3. Specifications are subject to change without notice.

Optical Characteristics Ta=25°C, unless otherwise specified

Parameter	Test condition	Symbol	Min	Typ.	Max	Unit
Open Circuit Voltage	Ee = 5mW/cm ² λ p= 940nm	Voc	---	0.4	---	V
Short Circuit Current	Ee = 1mW/cm ² λ p= 940nm	Isc	---	35	---	μA
Dark Current	Ee = 0mW/cm ² VR = 10V	ID	---	5	30	nA
Reverse Light Current	Ee = 1mW/cm ² λ p= 870nm VR = 5V	IL	18	25	---	μA
	Ee = 5mW/cm ² λ p= 940nm VR = 5V		25	37	---	
Total Capacitance	Ee = 0mW/cm ² VR = 3V f=1MHz	Ct	---	25	---	pF
Reverse Breakdown Voltage	Ee = 0mW/cm ² IR=100 μA	BVR	32	170	---	V
Range of Spectral Bandwidth	---	λ 0.5	730	---	1100	nm
Wavelength of Peak Sensitivity	---	λ p	---	940	---	nm
Rise Time	VR=10V, RL=1000Ω	tr	---	50	---	nS
Fall Time		tf	---	50	---	

Optical Characteristics Curves

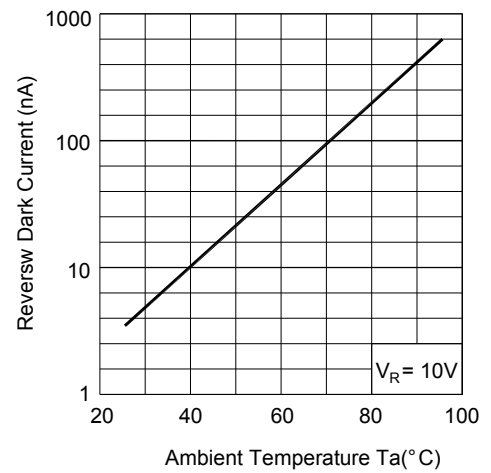
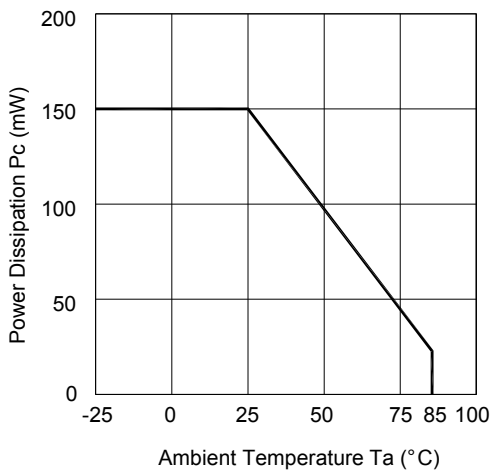
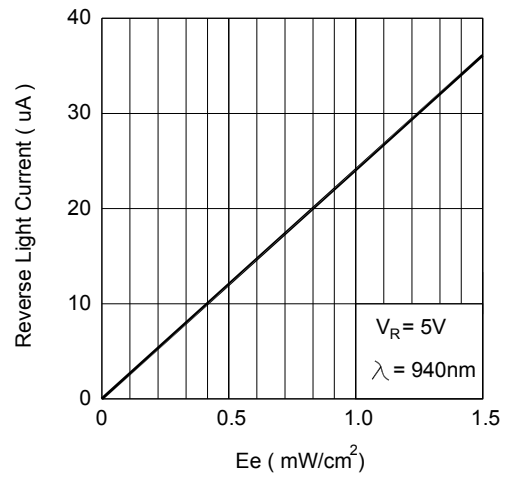
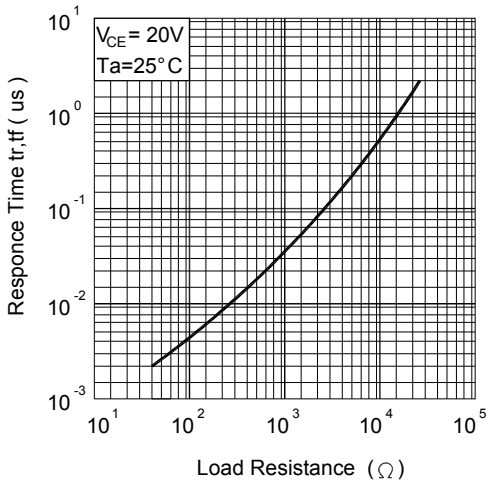
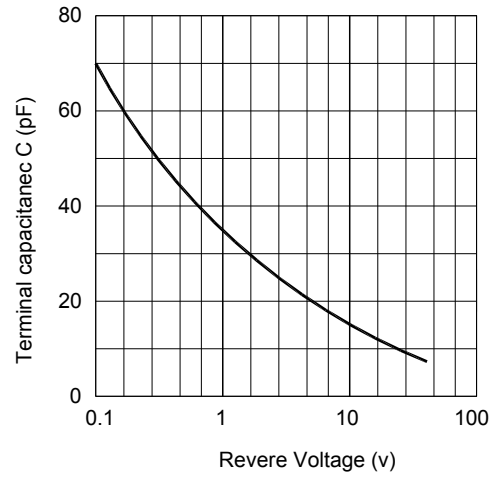
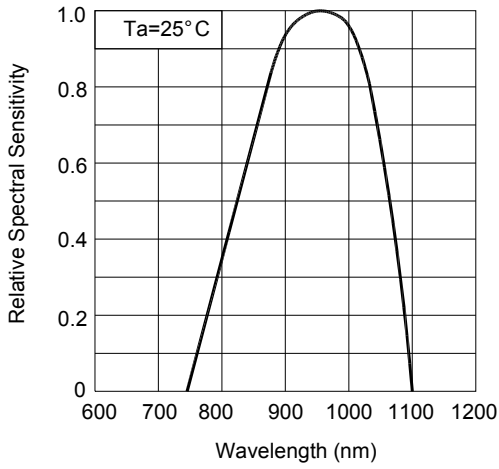

Reel Dimension:

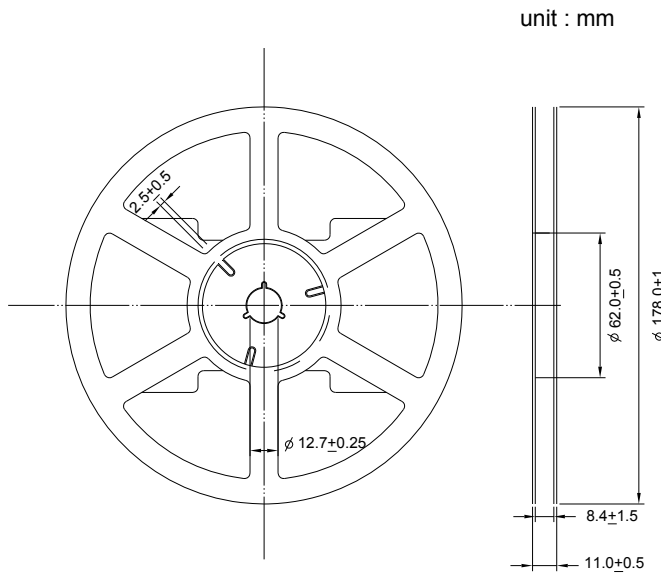

Note:

Available in 8mm carrier tape on 178mm diameter reels. (1000 pieces)

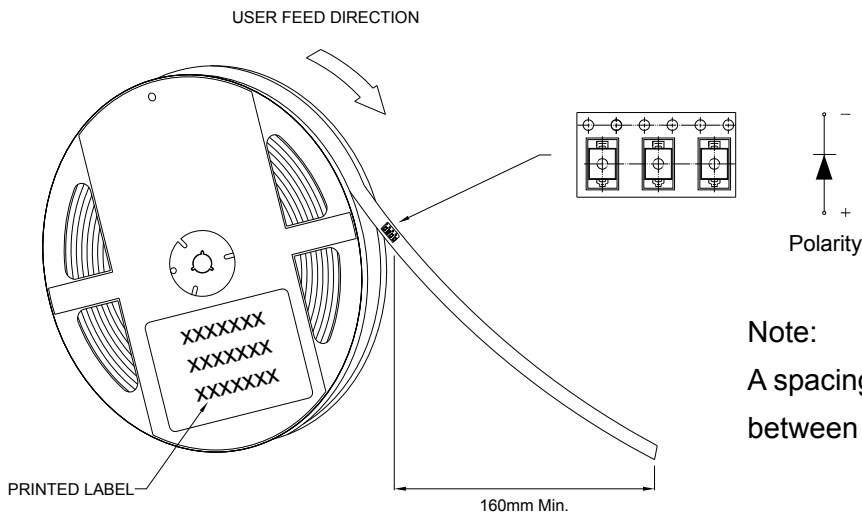

Note:

A spacing of approximately 160mm between the front edge of tape

Tape Dimension:

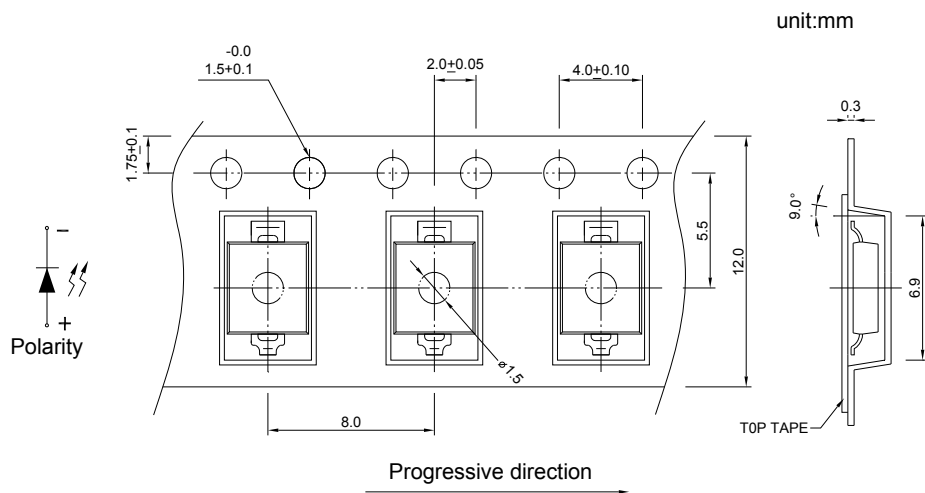

Recommended re-flow soldering profile:

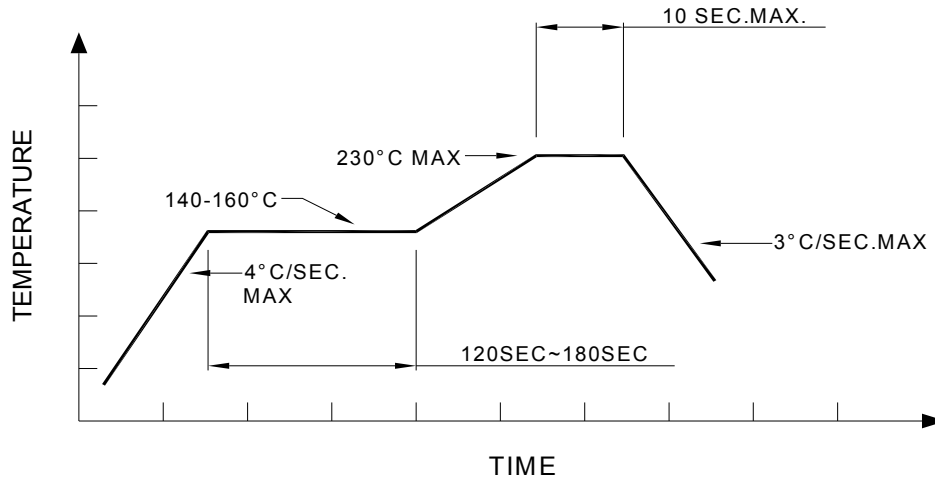

Recommended Pb-free re-flow soldering profile:

