

# Planar Package SMT Silicon Photodiode

## OD LA38

### Features

- High radiant sensitive
- Low junction capacitance
- Wide radiant sensitive area
- Fast respond speed.
- Lens in water clear

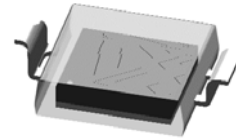

### Applications

- Industrial electronics
- Measurement
- Control Circuit
- Interrupter



### Absolute Maximum Rating T(amb) =25°C, unless otherwise specified

Parameter	Symbol	Value	Unit
Reverse Voltage	$V_R$	32	V
Power Dissipation	$P_C$	150	mW
Operating Temperature Range	$T_{opr}$	-30 to + 85	°C
Storage Temperature	$T_{stg}$	-40 to + 85	°C
Soldering Temperature	$T_{sol}$	260+/-5 for 5 sec	°C

Note: Please take note the Absolute Maximum Rating values. Any operation beyond the specified ratings in this table will result degradation of LED life- span and may cause LED to fail.

**Package Dimension:**

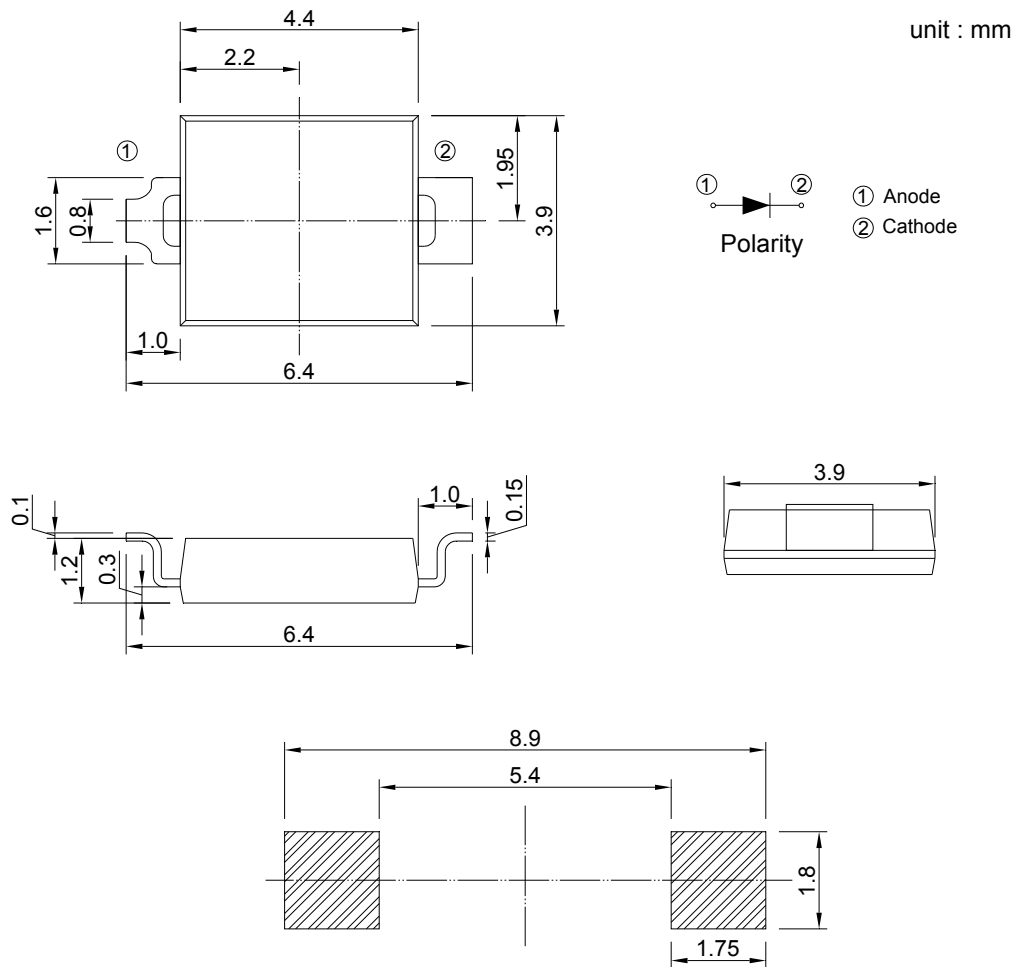

**Notes:**

1. All dimensions are millimeters.
2. Tolerance is  $\pm 0.2\text{mm}$  unless otherwise specified.
3. Specifications are subject to change without notice.

**Optical Characteristics Tamb=25°C, unless otherwise specified**

Parameter	Test condition	Symbol	Min	Typ.	Max	Unit
Open Circuit Voltage	Ee = 5mW/cm <sup>2</sup> λ p= 940nm	Voc	---	0.4	---	V
Short Circuit Current	Ee = 1mW/cm <sup>2</sup> λ p= 940nm	Isc	---	35	---	μA
Dark Current	Ee = 0mW/cm <sup>2</sup> VR = 10V	ID	---	5	30	nA
Reverse Light Current	Ee = 1mW/cm <sup>2</sup> λ p= 870nm VR = 5V	IL	18	25	---	μA
	Ee = 5mW/cm <sup>2</sup> λ p= 940nm VR = 5V		25	37	---	
Total Capacitance	Ee = 0mW/cm <sup>2</sup> VR = 3V f=1MHz	Ct	---	25	---	pF
Reverse Breakdown Voltage	Ee = 0mW/cm <sup>2</sup> IR=100 μA	BVR	32	170	---	V
Range of Spectral Bandwidth	---	λ 0.5	400	---	1100	nm
Wavelength of Peak Sensitivity	---	λ p	---	940	---	nm
Rise Time	VR=10V, RL=1000Ω	tr	---	50	---	nS
Fall Time		tf	---	50	---	

### Optical Characteristics Curves

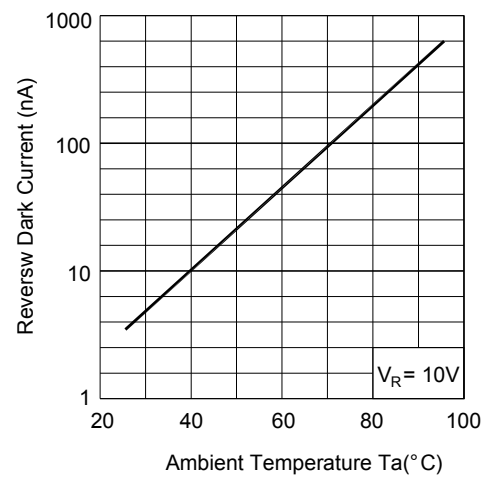
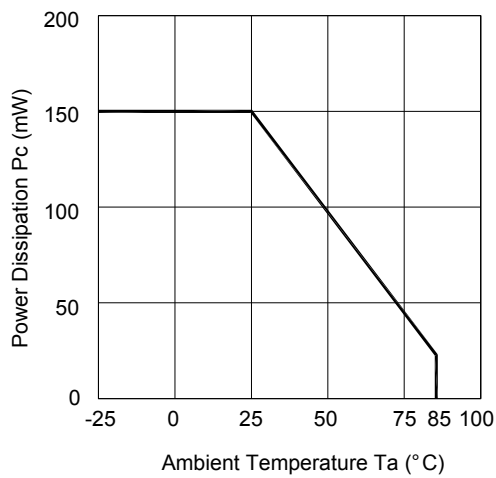
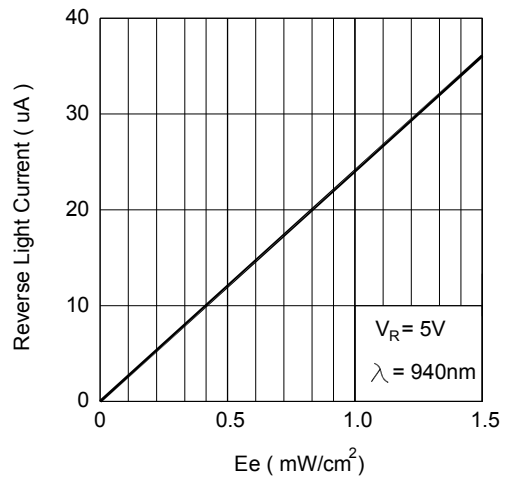
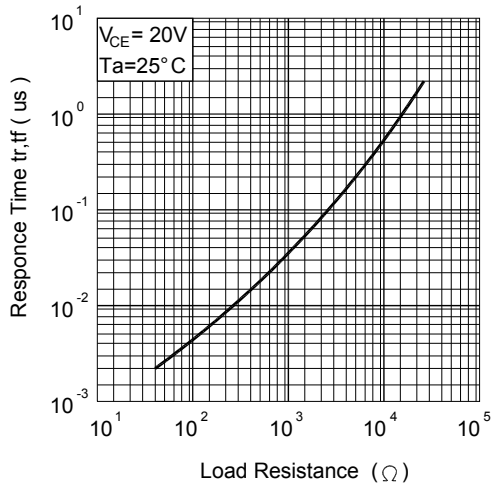
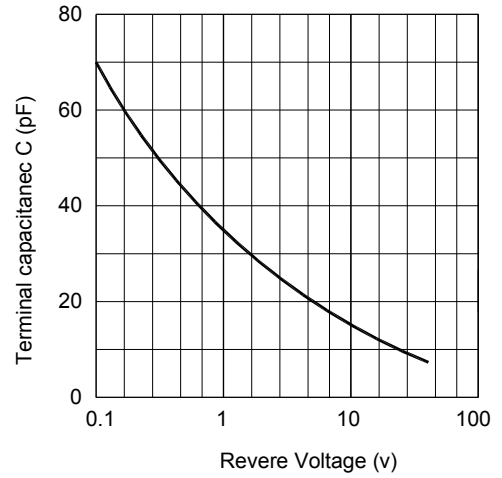
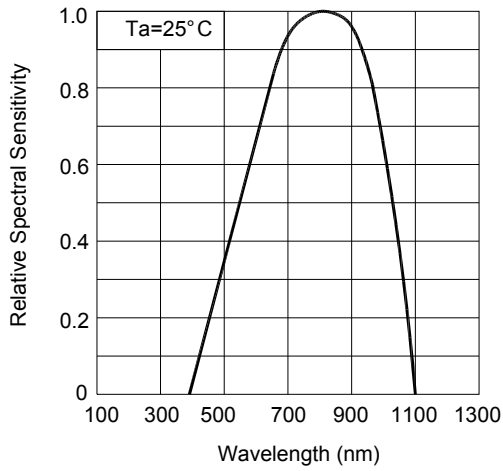

**Reel Dimension:**

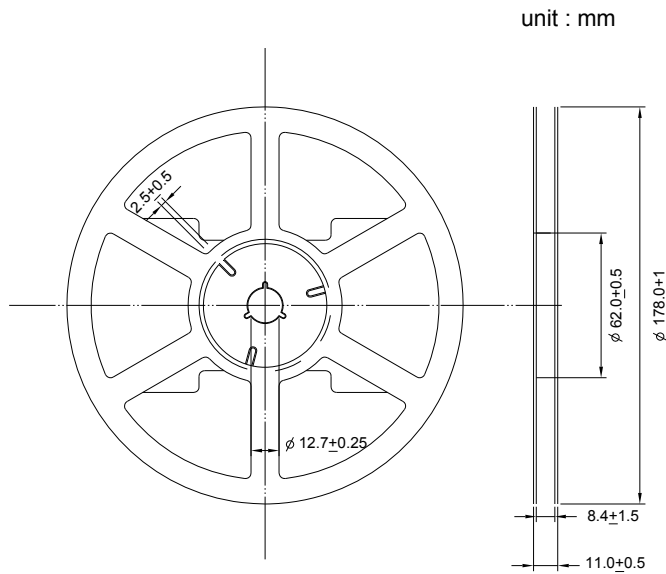

**Note:**

Available in 8mm carrier tape on 178mm diameter reels. (1000 pieces)

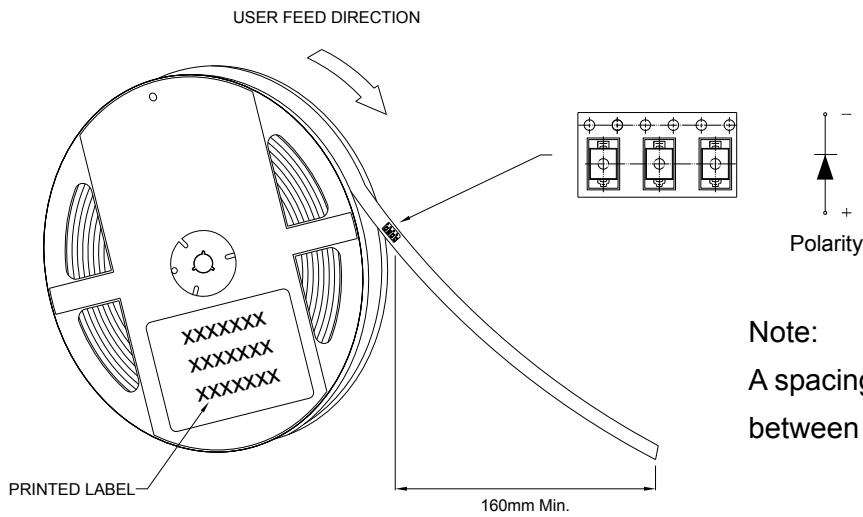

**Note:**

A spacing of approximately 160mm between the front edge of tape

**Tape Dimension:**

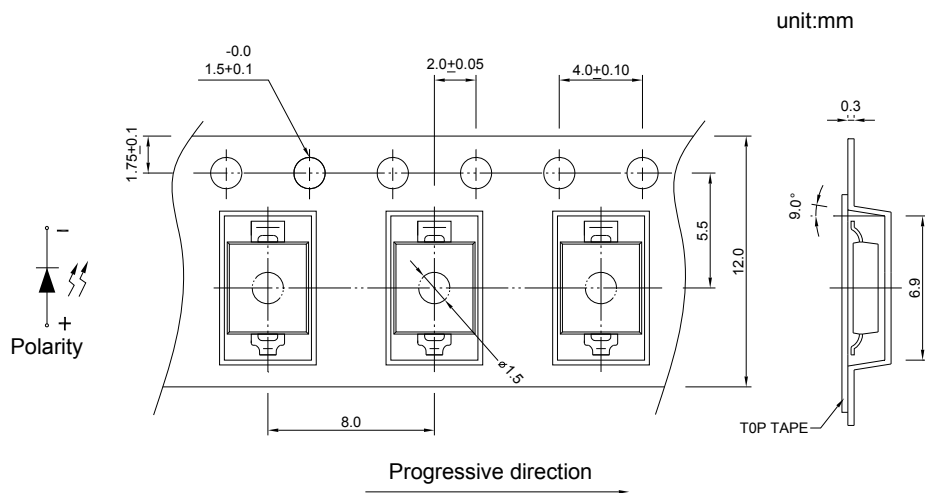

**Recommended re-flow soldering profile:**

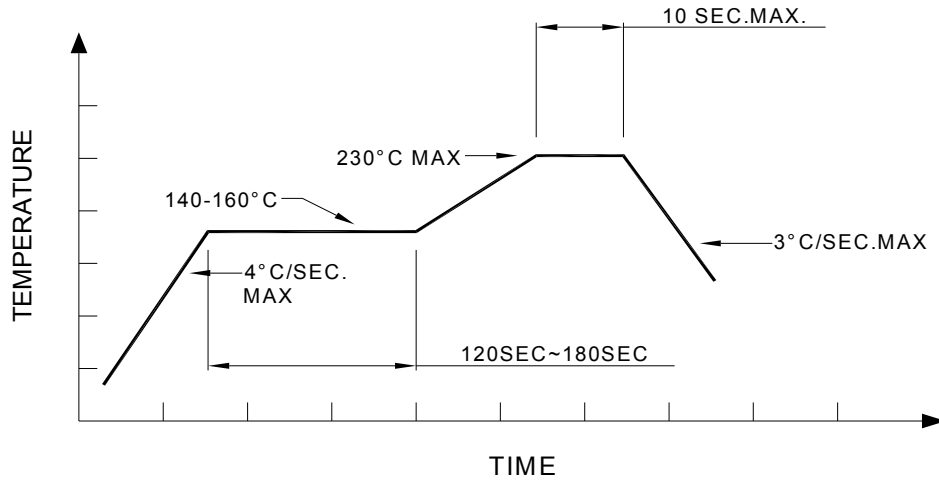

**Recommended Pb-free re-flow soldering profile:**

